

ZBGF

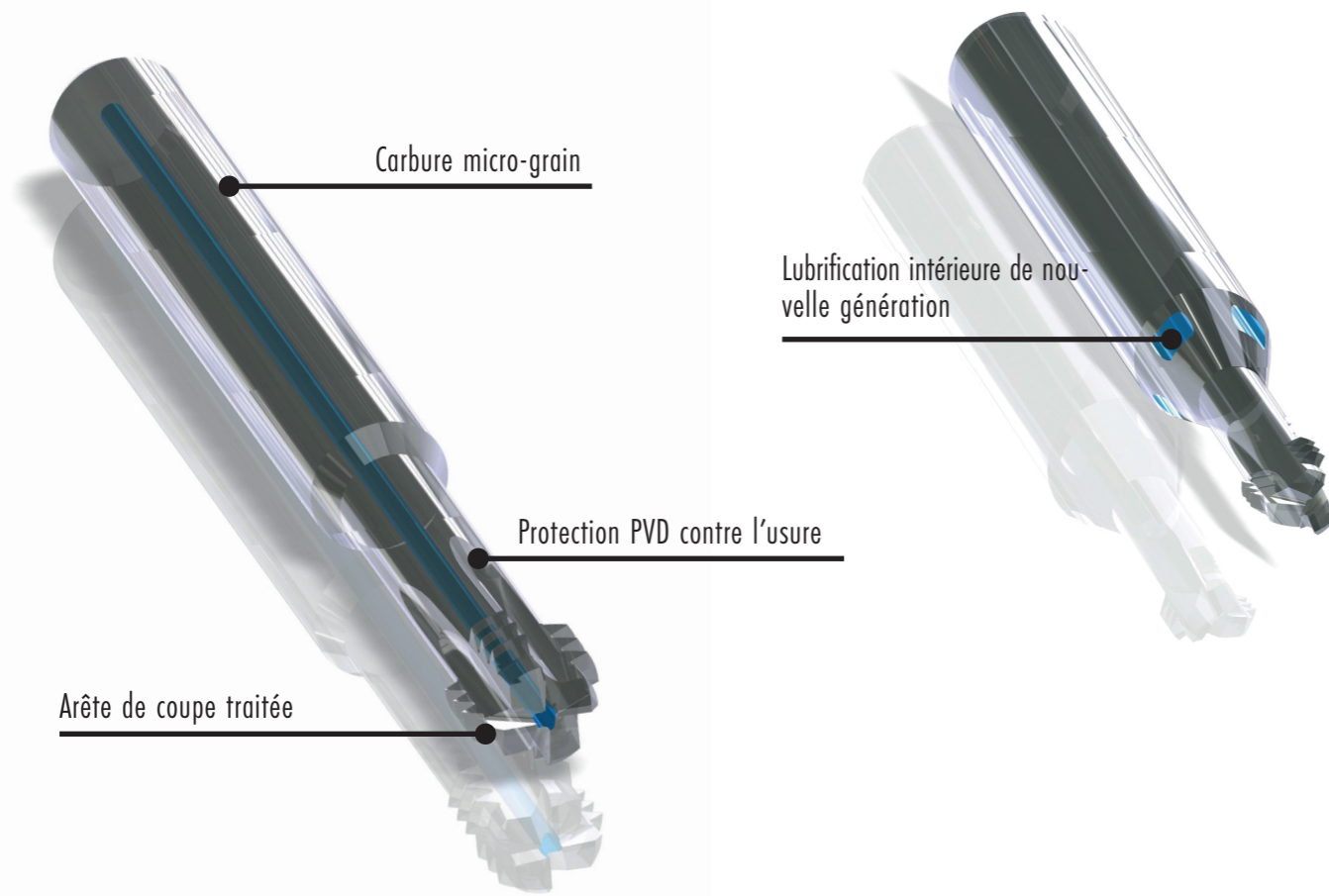

THREADING
TECHNOLOGY

Tourbillonneur - Perceur **ÉVOLUÉ**



Programme de fraisage

- Rotation antihoraire (coupe à gauche)
- Fraisage possible jusqu'à $3 \times D_1$
- Évacuation optimale des copeaux grâce à la lubrification intérieure (min 20 bar)

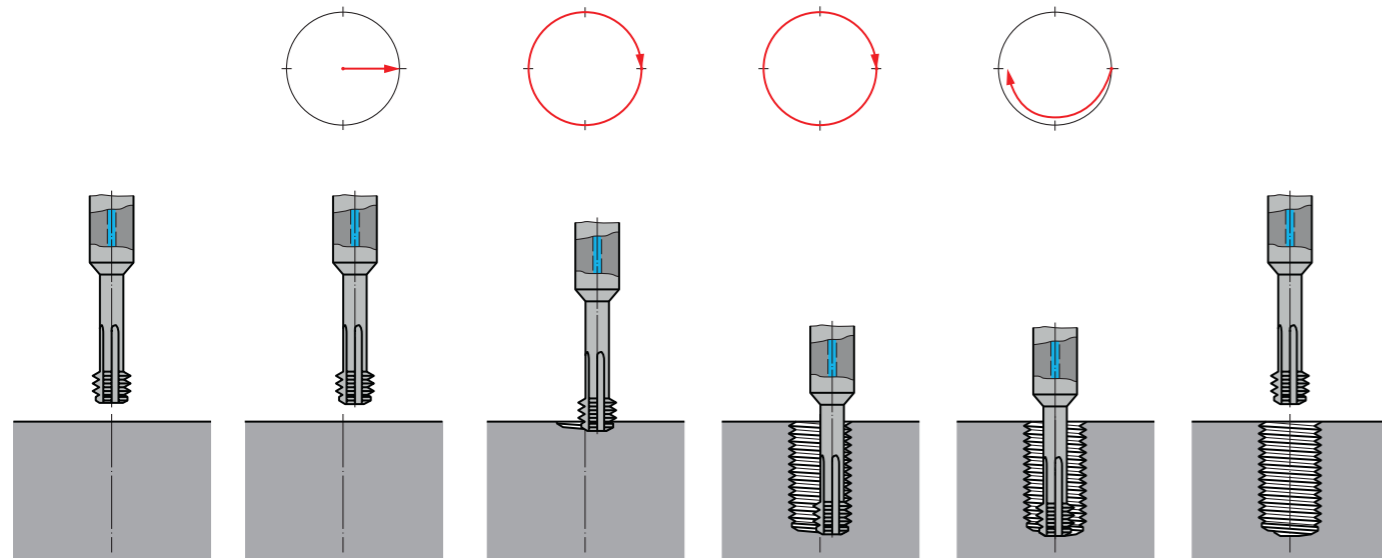

M ISO DIN 13

VHM
CAR



ZBGF

ZBGF6065VS



ZBGF6067VS

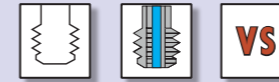

ZBGF6065VS

ZBGF6067VS

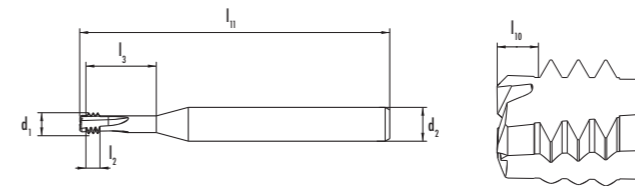

$\varnothing D_1$ M	P mm	d_1 mm	l_{11} mm	l_2 mm	l_3 mm	d_2 h6 mm	l_{10} mm		ID
3	0.50	2.43	55	1.5	7.5	4	0.75	3	181605
4	0.70	3.05	55	2.1	10.1	6	1.05	3	181606
5	0.80	4.08	55	2.4	12.4	6	1.20	3	181607
6	1.00	4.50	64	3.0	15.0	6	1.50	4	181608
8	1.25	5.95	64	3.8	19.8	6	1.88	4	181609
10	1.50	7.95	74	4.5	24.5	8	2.25	4	181610
12	1.75	9.95	80	5.3	29.3	10	2.63	4	181611
16	2.00	11.95	92	6.0	38.0	12	3.00	4	181612

$\varnothing D_1$ M	P mm	d_1 mm	l_{11} mm	l_2 mm	l_3 mm	d_2 h6 mm	l_{10} mm		ID
3	0.50	2.43	55	1.5	10.5	4	0.75	3	181613
4	0.70	3.05	55	2.1	14.1	6	1.05	3	181614
5	0.80	4.08	55	2.4	17.4	6	1.20	3	181615
6	1.00	4.50	72	3.0	21.0	6	1.50	4	181616
8	1.25	5.95	72	3.8	27.8	6	1.88	4	181617
10	1.50	7.95	90	4.5	34.5	8	2.25	4	181618
12	1.75	9.95	102	5.3	41.3	10	2.63	4	181619
16	2.00	11.95	115	6.0	54.0	12	3.00	4	181620

YouTube

UNC ANSI B1.1

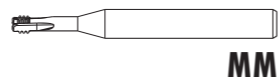

MM

ZBGF

ZBGF6065VS ZBGF6067VS

ZBGF6065VS

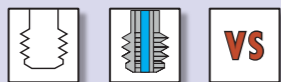

ZBGF6067VS

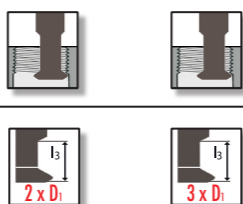
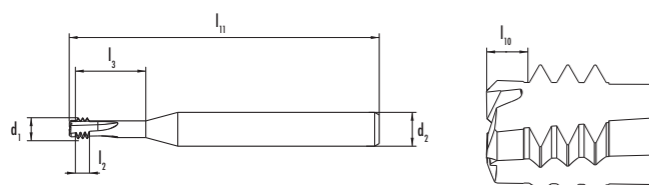
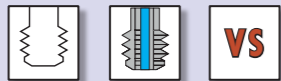

$\varnothing D_1$ UNCTPI	P mm	d_1 mm	l_{11} mm	l_2 mm	l_3 mm	$d_2 h_6$ mm	l_{10}	
4	40	2.11	55	1.9	7.6	4	0.95	3
6	32	2.59	55	2.4	9.4	4	1.19	3
8	32	3.10	55	2.4	10.8	6	1.19	3
10	24	3.60	55	3.2	12.9	6	1.59	3
1/4	20	4.80	64	3.8	16.6	6	1.91	4
5/16	18	5.95	64	4.2	20.2	6	2.12	4
3/8	16	7.10	74	4.8	23.9	8	2.38	4
1/2	13	9.95	80	5.9	31.3	10	2.93	4
5/8	11	11.95	92	6.9	38.7	12	3.46	4

ID

183509
183510
183511
183512
183513
183514
183515
183516
183517

$\varnothing D_1$ UNCTPI	P mm	d_1 mm	l_{11} mm	l_2 mm	l_3 mm	$d_2 h_6$ mm	l_{10}	
4	40	2.11	55	1.9	10.5	4	0.95	3
6	32	2.59	55	2.4	12.9	4	1.19	3
8	32	3.10	55	2.4	14.9	6	1.19	3
10	24	3.60	55	3.2	17.7	6	1.59	3
1/4	20	4.80	72	3.8	22.9	6	1.91	4
5/16	18	5.95	72	4.2	28.1	6	2.12	4
3/8	16	7.10	90	4.8	33.4	8	2.38	4
1/2	13	9.95	102	5.9	44.0	10	2.93	4
5/8	11	11.95	115	6.9	54.6	12	3.46	4

ID

183518
183519
183520
183521
183522
183523
183524
183525
183526

UNF ANSI B1.1

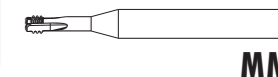

MM

ZBGF

ZBGF6065VS ZBGF6067VS

ZBGF6065VS

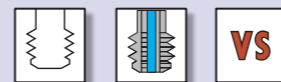

ZBGF6067VS

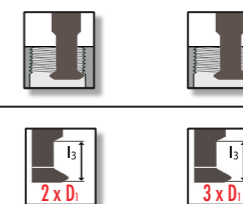
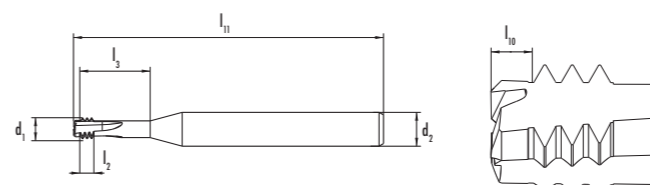
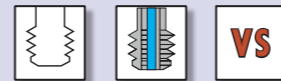

$\varnothing D_1$ UNFTPI	P mm	d_1 mm	l_{11} mm	l_2 mm	l_3 mm	$d_2 h_6$ mm	l_{10}	
4	48	2.23	55	1.6	7.3	4	0.79	3
8	36	3.10	55	2.1	10.5	6	1.06	3
10	32	3.91	55	2.4	12.1	6	1.19	3
1/4	28	4.80	64	2.7	15.5	6	1.36	4
5/16	24	5.95	64	3.2	19.1	6	1.59	4
3/8	24	7.10	74	3.2	22.3	8	1.59	4
7/16	20	7.95	74	3.8	26.1	8	1.91	4
1/2	20	9.95	80	3.8	29.3	10	1.91	4
5/8	18	11.95	92	4.2	36.0	12	2.12	4

ID

183527
183528
183529
183530
183531
183532
183533
183534
183535

$\varnothing D_1$ UNFTPI	P mm	d_1 mm	l_{11} mm	l_2 mm	l_3 mm	$d_2 h_6$ mm	l_{10}	
4	48	2.23	55	1.6	10.2	4	0.79	3
8	36	3.10	55	2.1	14.7	6	1.06	3
10	32	3.91	55	2.4	16.9	6	1.19	3
1/4	28	4.80	72	2.7	21.8	6	1.36	4
5/16	24	5.95	72	3.2	27.0	6	1.59	4
3/8	24	7.10	90	3.2	31.8	8	1.59	4
7/16	20	7.95	90	3.8	37.2	8	1.91	4
1/2	20	9.95	102	3.8	42.0	10	1.91	4
5/8	18	11.95	115	4.2	51.9	12	2.12	4

ID

183536
183537
183538
183539
183540
183541
183542
183543
183544

Vitesse de Coupe et Avances

Groupes de Matières	Désignation des matières	Dureté (HB)	Résistance Rm (N/mm ²)	Vc (m/min)		Avance fz (mm/dent)		SFM (f/min)		Avance fz (pouce/dent)
				Revêtu	Revêtu	Revêtu	Revêtu	Revêtu	Revêtu	
Aciers	11 Aciers de décolletage	< 200	< 700	50 – 100	0.020 – 0.060	164 – 328	0.0007 – 0.0023			0.0007 – 0.0023
	12 Aciers de construction / cémentation	< 200	< 700	50 – 100	0.010 – 0.050	164 – 328	0.0003 – 0.0019			0.0003 – 0.0019
	13 Aciers au carbone	< 300	< 1000	50 – 100	0.010 – 0.050	164 – 328	0.0003 – 0.0019			0.0003 – 0.0019
	14 Aciers alliés <850 N/mm ²	< 250	< 850	50 – 100	0.010 – 0.050	164 – 328	0.0003 – 0.0019			0.0003 – 0.0019
Aciers	15 Aciers alliés / traités >850 - <1150 N/mm ²	> 250	> 850	40 – 80	0.010 – 0.050	131 – 262	0.0003 – 0.0019			0.0003 – 0.0019
	16 Aciers haute résistance <55 HRC	> 250	> 850	30 – 60	0.008 – 0.040	98 – 197	0.0003 – 0.0015			0.0003 – 0.0015
Aciers Inoxydables	21 Aciers inoxydables / soufrés	< 250	< 850	40 – 80	0.010 – 0.040	131 – 262	0.0003 – 0.0015			0.0003 – 0.0015
	22 Austénitiques	< 250	< 850	30 – 50	0.010 – 0.040	98 – 164	0.0003 – 0.0015			0.0003 – 0.0015
	23 Ferritiques et martensitiques <850 N/mm ²	< 250	< 850	30 – 60	0.010 – 0.040	98 – 197	0.0003 – 0.0015			0.0003 – 0.0015
	24 Ferritiques et martensitiques >850 - <1150 N/mm ²	> 250	> 850	30 – 50	0.010 – 0.030	98 – 164	0.0003 – 0.0011			0.0003 – 0.0011
Fonte	31 Fonte grise	< 250	< 850	70 – 140	0.010 – 0.050	230 – 459	0.0003 – 0.0019			0.0003 – 0.0019
	32 Fonte à graphite sphéroïdale et malléable	< 250	< 850	50 – 100	0.010 – 0.050	164 – 328	0.0003 – 0.0019			0.0003 – 0.0019
Titane	41 Titane pur	< 250	< 850	30 – 50	0.010 – 0.040	98 – 164	0.0003 – 0.0015			0.0003 – 0.0015
	42 Alliage de titane	> 250	> 850	30 – 50	0.010 – 0.040	98 – 164	0.0003 – 0.0015			0.0003 – 0.0015
Nickel	51 Alliage de nickel 1 <850 N/mm ²	< 250	< 850	40 – 60	0.010 – 0.030	131 – 197	0.0003 – 0.0011			0.0003 – 0.0011
	52 Alliage de nickel 2 >850 - <1150 N/mm ²	> 250	> 850	30 – 50	0.010 – 0.030	98 – 164	0.0003 – 0.0011			0.0003 – 0.0011
	53 Alliage de nickel 3 >1150 - ≤1600 N/mm ²	> 340	> 1150	30 – 50	0.005 – 0.030	98 – 164	0.0002 – 0.0011			0.0002 – 0.0011
Cuivre	62 Laiton, bronze (copeaux courts)	< 200	< 700	100 – 200	0.010 – 0.050	328 – 656	0.0003 – 0.0019			0.0003 – 0.0019
	63 Laiton (copeaux longs)	< 200	< 700	100 – 200	0.010 – 0.050	328 – 656	0.0003 – 0.0019			0.0003 – 0.0019
Aluminium Magnésium	71 Al non allié	< 100	< 350	100 – 200	0.010 – 0.050	328 – 656	0.0003 – 0.0019			0.0003 – 0.0019
	72 Al allié Si < 1.5 %	< 150	< 500	100 – 200	0.010 – 0.050	328 – 656	0.0003 – 0.0019			0.0003 – 0.0019
	73 Al allié Si > 1.5 % - < 10 %	< 120	< 400	100 – 200	0.010 – 0.050	328 – 656	0.0003 – 0.0019			0.0003 – 0.0019
	74 Al allié Si > 10 %, Alliages Magnésium	< 120	< 400	70 – 140	0.010 – 0.050	230 – 459	0.0003 – 0.0019			0.0003 – 0.0019
Matières Plastiques	81 Matières thermoplastiques	.	.	80 – 180	0.050 – 0.100	262 – 590	0.0019 – 0.0039			0.0019 – 0.0039
	82 Matières duroplastiques	.	.	80 – 180	0.020 – 0.080	262 – 590	0.0007 – 0.0031			0.0007 – 0.0031
	83 Matières plastiques renforcées par fibres	.	.	50 – 150	0.020 – 0.100	164 – 492	0.0007 – 0.0039			0.0007 – 0.0039
Matières Précieuses	91 Or jaune	.	.	80 – 120	0.020 – 0.080	262 – 394	0.0007 – 0.0031			0.0007 – 0.0031
	92 Or rose	.	.	50 – 100	0.010 – 0.050	164 – 328	0.0003 – 0.0019			0.0003 – 0.0019
	93 Or gris	.	.	40 – 80	0.010 – 0.040	131 – 262	0.0003 – 0.0015			0.0003 – 0.0015
	94 Argent	.	.	50 – 100	0.010 – 0.050	164 – 328	0.0003 – 0.0019			0.0003 – 0.0019